

INTEGRATED E-Z SPLIT KEY® CUP II Procedure Card

Available with Specimen Validity Tests (S.V.T.)

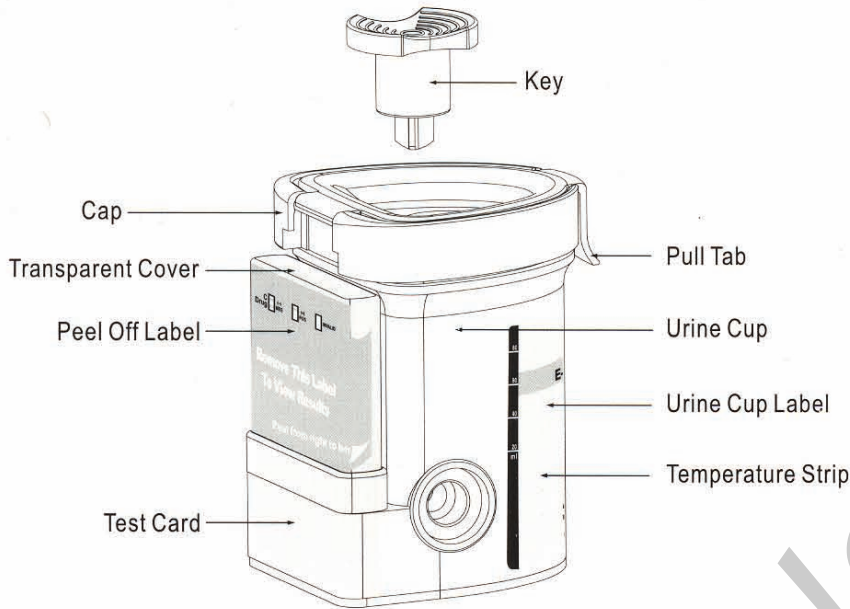

Date _____ Initials _____

Security Seal ← Security Seal

1 Remove the key by twisting it from the center of the cup cap. Open cap with the Pull Tab. (Key is held by technician.)

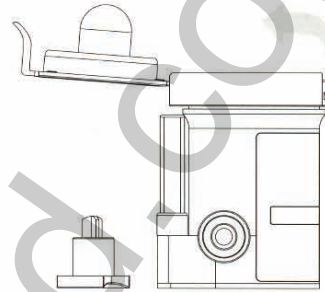

2 Donor provides specimen and secures cap. Note: Secure cap by pressing down on the Pull Tab until an audible click is heard.

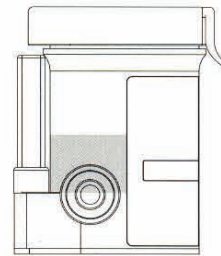

3 Check cap for tight seal. Technician dates and initials the security seal and places security seal over cap.

Date _____ Initials _____

Security Seal

Place security seal over cup

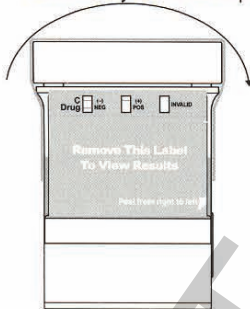

4 On a flat surface, technician inserts the key and pushes in.

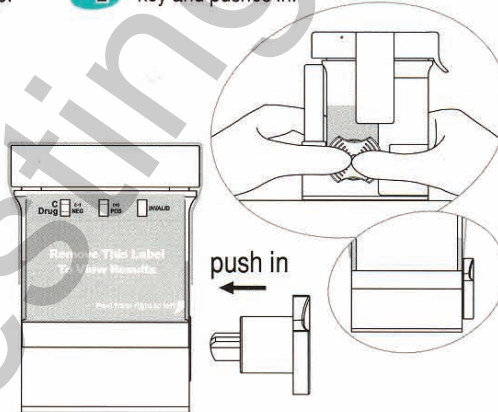

5 Peel off the label to view results.

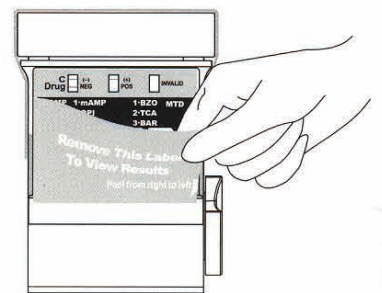

6 If the test cup includes S.V.T., read adulteration test results between 3 - 5 minutes.

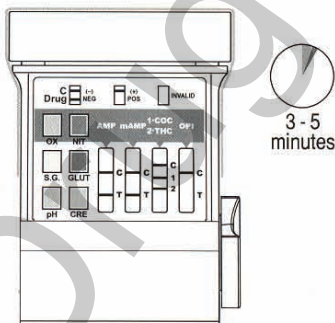

Adulteration Strips
See color chart and package insert for interpretation.

7 Read drug test results at 5 minutes.

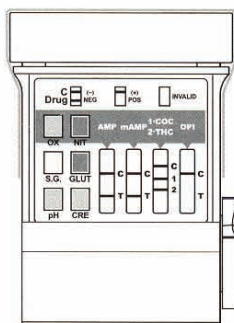

Example: Test shows positive for OPI.



C Drug **NEGATIVE**

C Drug **POSITIVE**

C Drug **INVALID**

All positive results are presumptive and should be confirmed by an alternative method. (e.g. GC/MS)

8 A photocopy of the drug test results can be made by placing the entire cup with the card face down on the copier.

